

XS1N18PA349

Inductive proximity sensors XS, inductive sensor XS1 M18, L39mm, brass, Sn10mm, 12...24 VDC, cable 2 m



Product availability: Stock - Normally stocked in distribution facility

Price*: 100.00 USD

Main

Range of product	Telemecanique Inductive proximity sensors XS
Series name	General purpose
Sensor type	Inductive proximity sensor
Device application	-
Sensor name	XS1
Sensor design	Cylindrical M18
Size	39 mm
Body type	Fixed
Detector flush mounting acceptance	Flush mountable
Material	Metal
Enclosure material	Nickel Plated Brass
Type of output signal	Discrete
Wiring technique	3-wire
[Sn] nominal sensing distance	0.39 In (10 mm)
Discrete output function	1 NO
Output circuit type	DC
Discrete output type	PNP
Electrical connection	Cable
Cable length	6.56 Ft (2 m)
[Us] rated supply voltage	12...24 V DC reverse polarity protection
Switching capacity in mA	<= 200 mA DC with overload and short-circuit protection
IP degree of protection	IP68 double insulation conforming to IEC 60529 IP69K conforming to DIN 40050

Complementary

Thread type	M18 x 1
Detection face	Frontal
Front material	PPS
Operating zone	0.00...0.31 ln (0...8 mm)
Differential travel	1...15% of Sr
Cable composition	3 x 0.34 mm ²
Wire insulation material	PvR
Status LED	Output state: 1 LED (yellow)
Supply voltage limits	10...36 V DC
Switching frequency	<= 1000 Hz
Maximum voltage drop	<2 V (closed)
Current consumption	0...10 mA no-load
Maximum delay first up	5 Ms
Maximum delay response	0.3 Ms
Maximum delay recovery	0.7 Ms
Marking	CE
Threaded length	1.10 ln (28 mm)
Height	0.71 ln (18 mm)
Length	1.54 ln (39 mm)
Net weight	0.22 Lb(US) (0.1 kg)

Environment

Product certifications	UL CSA
Ambient air temperature for operation	-13...122 °F (-25...50 °C)
Ambient air temperature for storage	-40...185 °F (-40...85 °C)
Vibration resistance	25 gn +/- 2 mm 10...55 Hz)IEC 60068-2-6
Shock resistance	50 gn 11 ms IEC 60068-2-27

Ordering and shipping details

Category	22486 - SENSORS, PROXIMITY
Discount Schedule	DS2
GTIN	03389110911565
Nbr. of units in pkg.	1
Package weight(Lbs)	3.39 Oz (96 g)
Returnability	Yes
Country of origin	FR

Packing Units

Unit Type of Package 1	PCE
Package 1 Height	1.61 ln (4.1 cm)
Package 1 width	3.74 ln (9.5 cm)
Package 1 Length	5.12 ln (13 cm)

Offer Sustainability

Sustainable offer status	Green Premium product
California proposition 65	WARNING: This product can expose you to chemicals including: Diisononyl phthalate (DINP), which is known to the State of California to cause cancer, and Diisodecyl phthalate (DIDP), which is known to the State of California to cause birth defects or other reproductive harm. For more information go to www.P65Warnings.ca.gov
REACH Regulation	REACH Declaration
EU RoHS Directive	Pro-active compliance (Product out of EU RoHS legal scope) EU RoHS Declaration
Mercury free	Yes
RoHS exemption information	Yes
Environmental Disclosure	Product Environmental Profile
Circularity Profile	End Of Life Information

Contractual warranty

Warranty	18 months
----------	-----------

Dimensions

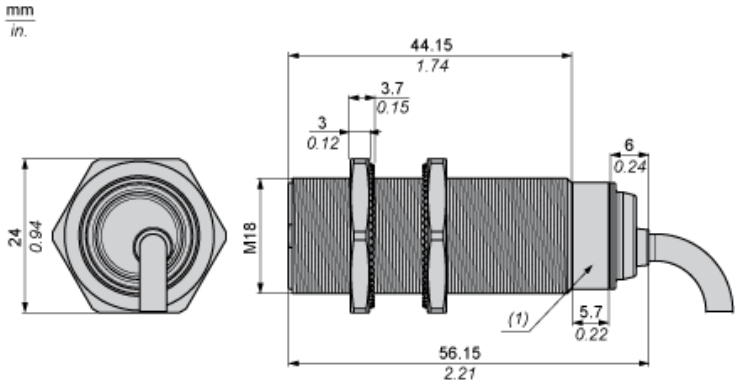

(1) LED

Minimum Mounting Distances

Side by side

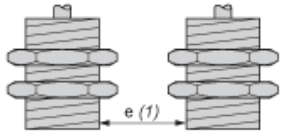

$e (1) \geq 20 \text{ mm} / 0.79 \text{ in.}$

Face to face

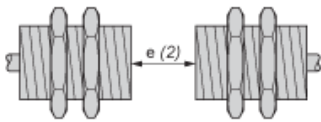

$e (2) \geq 6 \text{ mm} / 3.78 \text{ in.}$

Facing a metal object

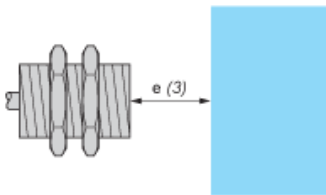

$e (3) \geq 30 \text{ mm} / 1.18 \text{ in.}$

Mounted in a metal support

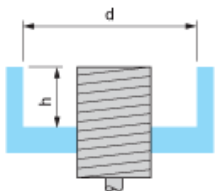

$d \geq 28 \text{ mm} / 1.10 \text{ in.}$

$h \geq 3.6 \text{ mm} / 0.14 \text{ in.}$

Mounting

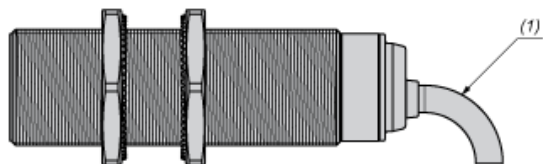

(1) Bending cable: 4 x external cable diameter

Wiring Schemes

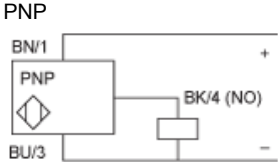

BU : Blue
BN : Brown
BK : Black

Performance Curves

Standard Steel Target : 18x18x1 mm

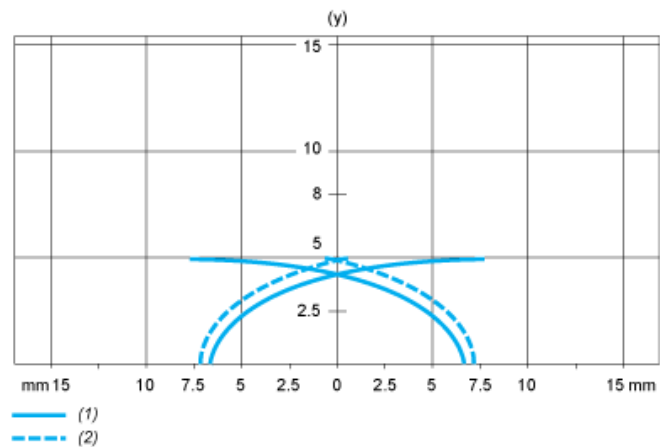

- (1) Pick-up points
- (2) Drop-out points (object approaching from the side)
- (y) Sensing distance in mm

Product Life Status : **Commercialised**